



indoseals™

An associate of ND Thakare
ISO 9001-2015



Mechanical Seals Total Solutions

Rubber Bellow Seal - ISPL 2412

- ◆ Unbalanced single spring seal
- ◆ Flexible synthetic rubber bellow
- ◆ Dependent on direction of rotation
- ◆ Inside mounted

Applications:

- ◆ Mass produced cold water pumps for non-critical applications
- ◆ Centrifugal pumps, plastic immersion pumps, vortex vacuum pumps
- ◆ Reduction gearboxes for cane carrier, rack carrier, bagasse elevators, crystalliser & cane gear box
- ◆ Compressor for refrigeration of Ammonia & Freon gasses

Most versatile and widely used in a variety of applications as it is easy to install and economical. Shaft run out is compensated by rubber bellow and spring due to its self aligning capability. Also produced with balanced ring for higher pressures upto 1000psi. Rubber bellow seals are available in different types.

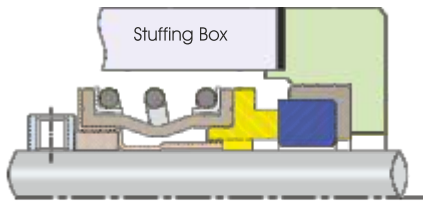

ISPL-2412 A Open Type Seal

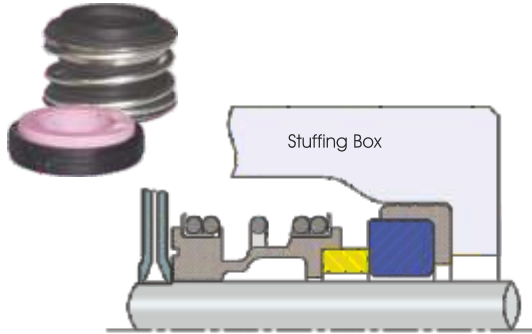

ISPL-2412 B Short Bellow Seal

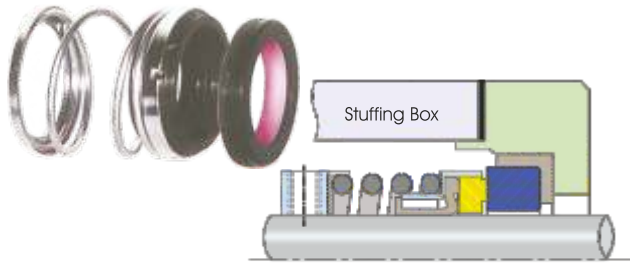

ISPL-2412 E Robin Type

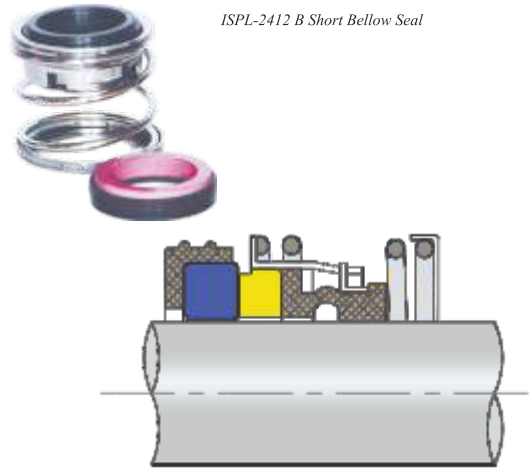

ISPL-2412 C Crane Type

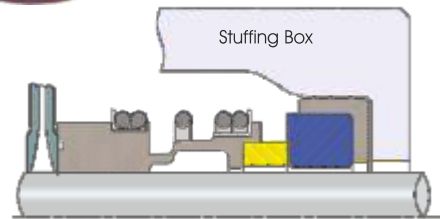

ISPL-2412 F Long Bellow Type MG12

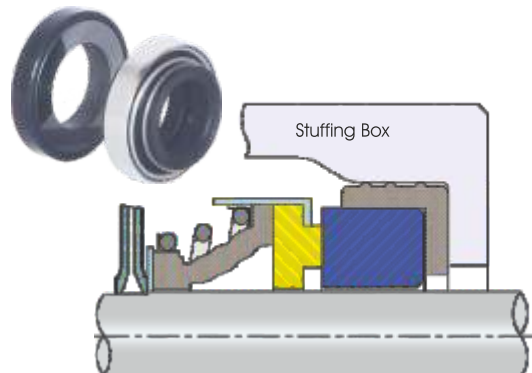

ISPL-2412 D Close Type Seal

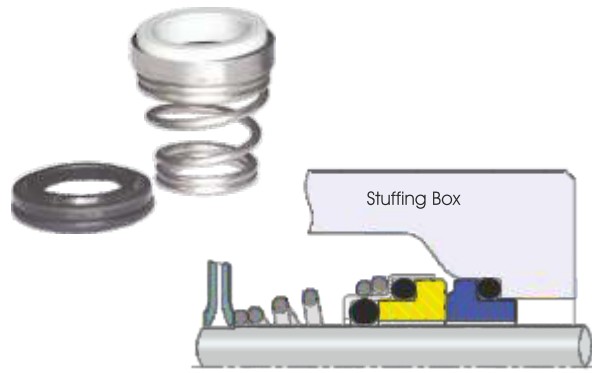

ISPL-2412 G-J1 Type

Use Indoseals....avoid plant pollution

Certified By:





- Nashik
- Pune
- Mumbai
- Kolhapur
- Hyderabad
- Bangalore
- Vijaywada
- Chennai
- Ahmedabad
- Barodra
- Kolkata
- New Delhi
- Sharanpur
- Lucknow
- Raipur
- Jaipur

Contact us:

For Sales:
sales@indoseals.com
Cell No.: +91 7447439162

For Services:
service@indoseals.com
Cell No.: +91 9881301631



An associate of ND Thakare

Indoseals P. Ltd.

Mfgs. of Mechanical seals & spares, Rotary unions

Regd. Office & factory: W-97A, First Floor, MIDC, [behind Hardy Spicer] Ambad,
Nashik - 422010, Maharashtra, INDIA
Phone: +91 253 2384705; +91 253 2384575
Fax: +91 253 2384705, Cell: +91 9881301631
e-mail: sales@indoseals.com ; info@indoseals.com; Website: www.indoseals.com

Certified By:

